

For all other information see  
Report of Survey No 306 24/4/54

Two 3/8" Coach Screws  
Through Each End of  
Mast Step in  
Addition to Keel Bolts

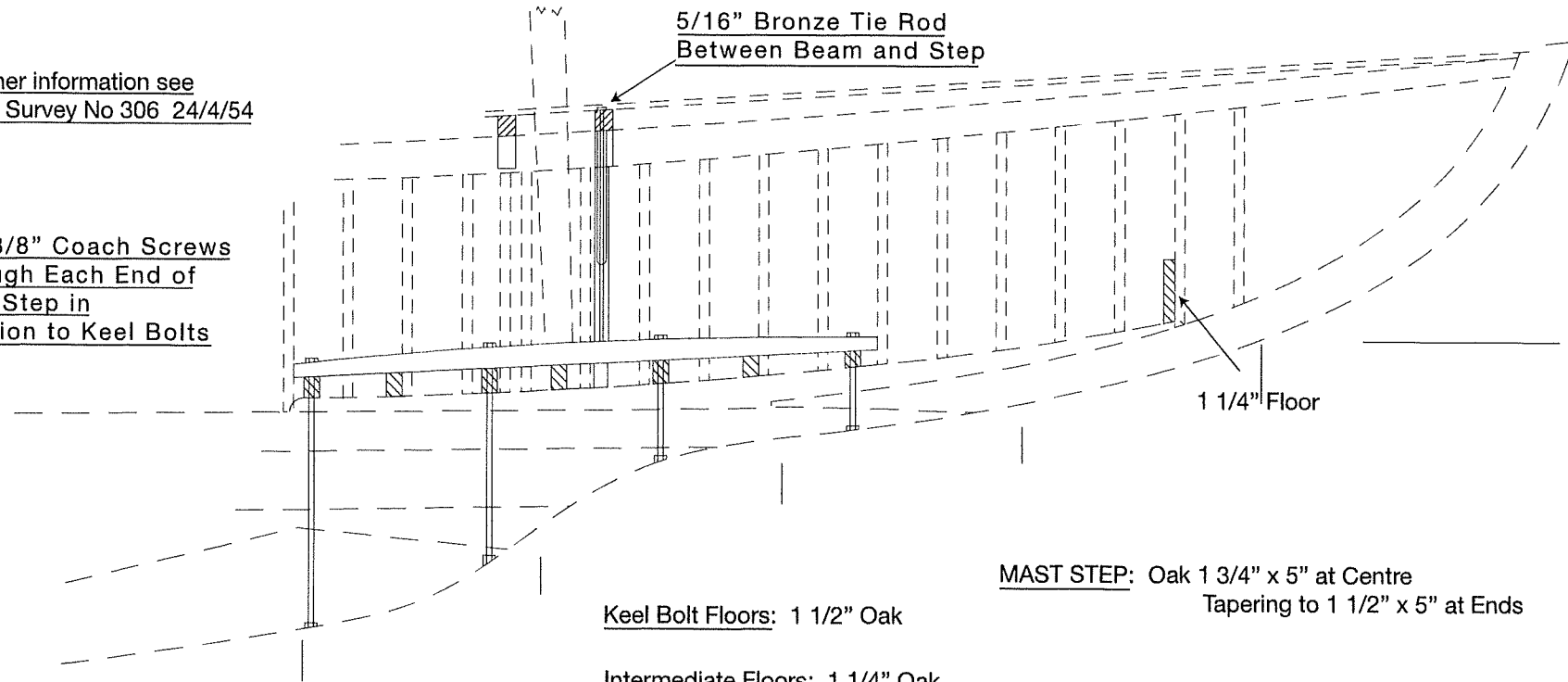

MAST STEP: Oak 1 3/4" x 5" at Centre  
Tapering to 1 1/2" x 5" at Ends

Additional Frames in Way of  
Mast Beams 1 1/4" x 7/16" Oak

1 1/8" Grown Oak Hanging  
Knee. Fix 3/16" Copper

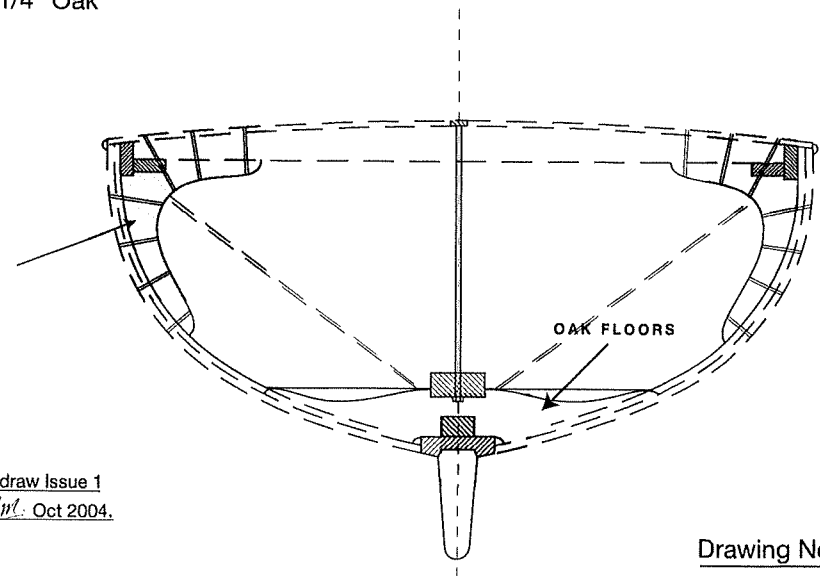

Details of Additional Strengthening in Way of  
Mast Step for Royal Corinthian One Design

Scale 0.707" = 1.0'

Redraw Issue 1  
A.M. Oct 2004.

ROYAL CORINTHIAN YACHT CLUB  
ONE DESIGN CLASS

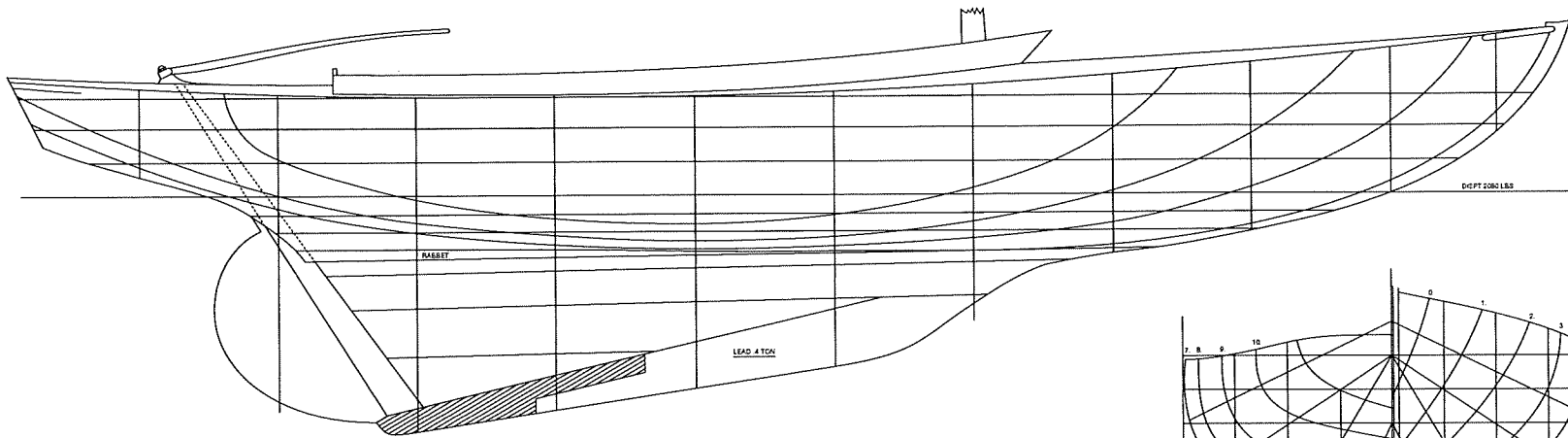
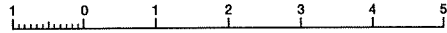

LENGTH O.A. 22.5'. W.L. 17'. BEAM 6'. DRAUGHT 3.5'. SAIL AREA 225'.

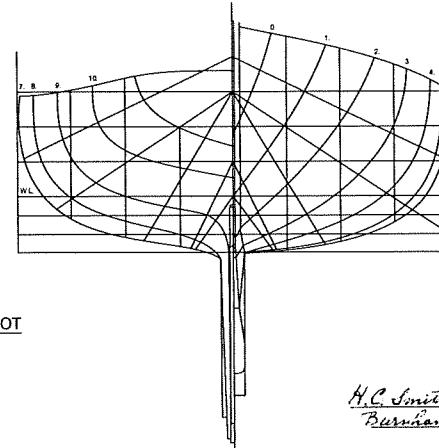

SCALE 3/8" = 1 FOOT

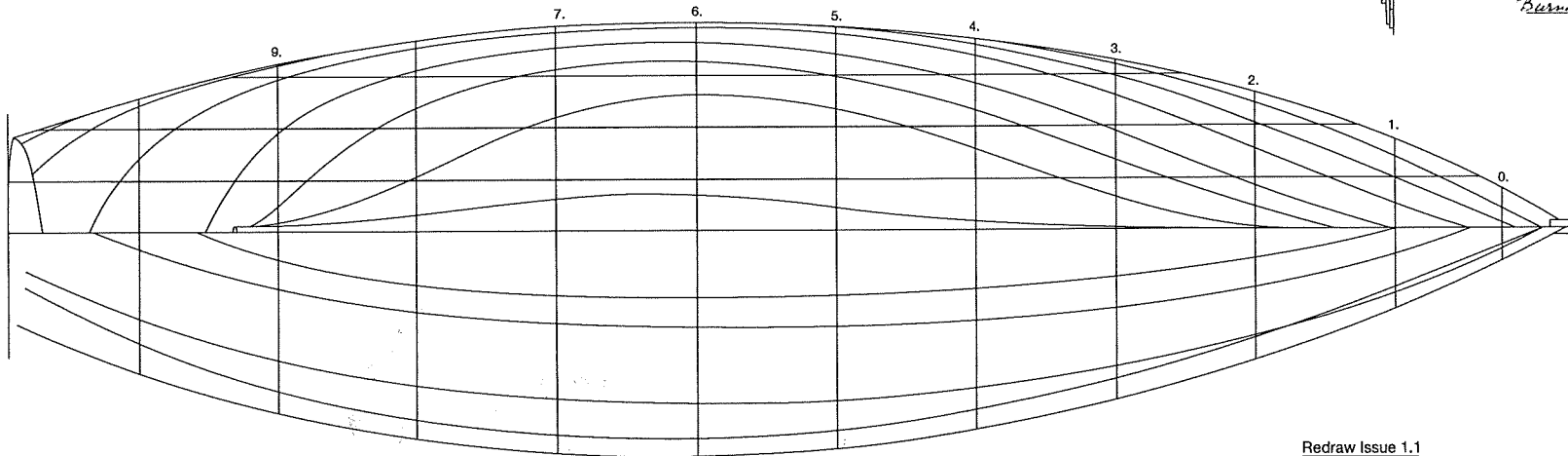

*H.C. Smith ADINA  
Barnham-on-Crouch  
July 1934.*

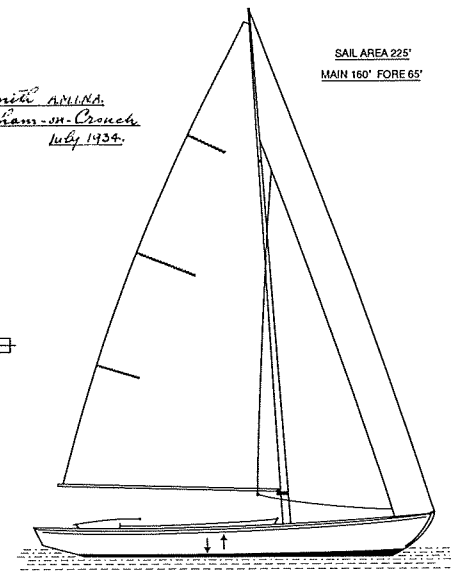

Scale 3/32" = 1 foot

Redraw Issue 1.1  
*V.R.M.* Oct 2004.